



VND1NV04 VNN1NV04 - VNS1NV04

OMNIFET II
fully autoprotected Power MOSFET

Features

| Parameter | Symbol | Value |
|-----------------------------------|-------------|----------------|
| Max on-state resistance (per ch.) | R_{ON} | 250 m Ω |
| Current limitation (typ) | I_{LIMH} | 1.7 A |
| Drain-source clamp voltage | V_{CLAMP} | 40 V |

- Linear current limitation
- Thermal shutdown
- Short circuit protection
- Integrated clamp
- Low current drawn from input pin
- Diagnostic feedback through input pin
- ESD protection
- Direct access to the gate of the Power MOSFET (analog driving)
- Compatible with standard Power MOSFET

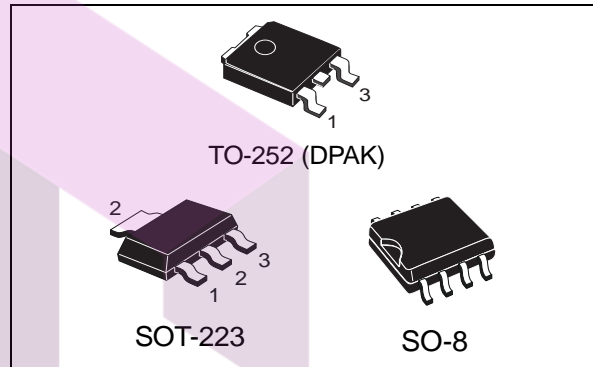

Description

The VND1NV04, VNN1NV04, VNS1NV04 are monolithic devices designed in STMicroelectronics® VIPower® M0-3 Technology, intended for replacement of standard Power MOSFETs from DC up to 50 KHz applications. Built in thermal shutdown, linear current limitation and overvoltage clamp protect the chip in harsh environments.

Fault feedback can be detected by monitoring the voltage at the input pin.

Table 1. Device summary

| Package | Order codes | | | |
|---------------|-------------|------------------|---------------|---------------------------|
| | Tube | Tube (lead free) | Tape and reel | Tape and reel (lead free) |
| TO-252 (DPAK) | VND1NV04 | VND1NV04-E | VND1NV0413TR | VND1NV04TR-E |
| SOT-223 | VNN1NV04 | - | VNN1NV0413TR | - |
| SO-8 | VNS1NV04 | - | VNS1NV0413TR | - |

Contents

| | | |
|----------|--|-----------|
| 1 | Block diagram and pin description | 5 |
| 2 | Electrical specifications | 6 |
| 2.1 | Absolute maximum ratings | 6 |
| 2.2 | Thermal data | 7 |
| 2.3 | Electrical characteristics | 7 |
| 2.4 | Electrical characteristics curves | 12 |
| 3 | Protection features | 16 |
| 4 | Package and PCB thermal data | 17 |
| 4.1 | DPAK thermal data | 17 |
| 4.2 | SOT-223 thermal data | 19 |
| 4.3 | SO-8 thermal data | 22 |
| 5 | Package and packing information | 25 |
| 5.1 | DPAK mechanical data | 25 |
| 5.2 | SOT-223 mechanical data | 27 |
| 5.3 | SO8 mechanical data | 27 |
| 5.4 | DPAK packing information | 29 |
| 5.5 | SOT-223 packing information | 30 |
| 5.6 | SO8 packing information | 31 |
| 6 | Revision history | 32 |

SKYTECH

تهیه و توزیع قطعات الکترونیک

List of tables

| | | |
|-----------|--------------------------------------|----|
| Table 1. | Device summary | 1 |
| Table 2. | Absolute maximum ratings | 6 |
| Table 3. | Thermal data | 7 |
| Table 4. | Electrical characteristics | 7 |
| Table 5. | DPAK thermal parameter | 19 |
| Table 6. | SOT-223 thermal parameter | 21 |
| Table 7. | SO-8 thermal parameter | 24 |
| Table 8. | DPAK mechanical data | 26 |
| Table 9. | SO-8 mechanical data | 27 |
| Table 10. | Document revision history | 32 |



SKYTECH

تهیه و توزیع قطعات الکترونیک

List of figures

| | | |
|------------|--|----|
| Figure 1. | Block diagram | 5 |
| Figure 2. | Configuration diagram (top view) | 5 |
| Figure 3. | Current and voltage conventions | 6 |
| Figure 4. | Switching time test circuit for resistive load | 9 |
| Figure 5. | Test circuit for diode recovery times | 10 |
| Figure 6. | Unclamped inductive load test circuits | 10 |
| Figure 7. | Input charge test circuit | 11 |
| Figure 8. | Unclamped inductive waveforms | 11 |
| Figure 9. | Source-drain diode forward characteristics | 12 |
| Figure 10. | Static drain-source on resistance | 12 |
| Figure 11. | Derating curve | 12 |
| Figure 12. | Static drain-source on resistance vs. input voltage (part 1/2) | 12 |
| Figure 13. | Static drain-source on resistance vs. input voltage (part 2/2) | 12 |
| Figure 14. | Transconductance | 12 |
| Figure 15. | Static drain-source on resistance vs. I_d | 13 |
| Figure 16. | Transfer characteristics | 13 |
| Figure 17. | Turn-on current slope (part 1/2) | 13 |
| Figure 18. | Turn-on current slope (part 2/2) | 13 |
| Figure 19. | Input voltage vs. input charge | 13 |
| Figure 20. | Turn-off drain source voltage slope (part 1/2) | 13 |
| Figure 21. | Turn-off drain-source voltage slope (part 2/2) | 14 |
| Figure 22. | Capacitance variations | 14 |
| Figure 23. | Switching time resistive load (part 1/2) | 14 |
| Figure 24. | Switching time resistive load (part 2/2) | 14 |
| Figure 25. | Output characteristics | 14 |
| Figure 26. | Normalized on resistance vs. temperature | 14 |
| Figure 27. | Normalized input threshold voltage vs. temperature | 15 |
| Figure 28. | Normalized current limit vs. junction temperature | 15 |
| Figure 29. | Step response current limit | 15 |
| Figure 30. | DPAK PC board | 17 |
| Figure 31. | DPAK $R_{thj-amb}$ vs. PCB copper area in open box free air condition | 17 |
| Figure 32. | DPAK thermal impedance junction ambient single pulse | 18 |
| Figure 33. | DPAK thermal fitting model of a single channel | 18 |
| Figure 34. | SOT-223 PC board | 19 |
| Figure 35. | SOT-223 $R_{thj-amb}$ vs. PCB copper area in open box free air condition | 20 |
| Figure 36. | SOT-223 thermal impedance junction ambient single pulse | 20 |
| Figure 37. | SOT-223 thermal fitting model of a single channel | 21 |
| Figure 38. | SO-8 PC board | 22 |
| Figure 39. | SO-8 $R_{thj-amb}$ vs. PCB copper area in open box free air condition | 22 |
| Figure 40. | SO-8 thermal impedance junction ambient single pulse | 23 |
| Figure 41. | SO-8 thermal fitting model of a single channel | 23 |
| Figure 42. | DPAK package dimensions | 25 |
| Figure 43. | SOT-223 mechanical data & package outline | 27 |
| Figure 44. | SO-8 package dimension | 28 |
| Figure 45. | SOT-223 tape and reel shipment (suffix "TR") | 30 |
| Figure 46. | SO-8 tube shipment (no suffix) | 31 |
| Figure 47. | SO-8 tape and reel shipment (suffix "TR") | 31 |

1 Block diagram and pin description

Figure 1. Block diagram

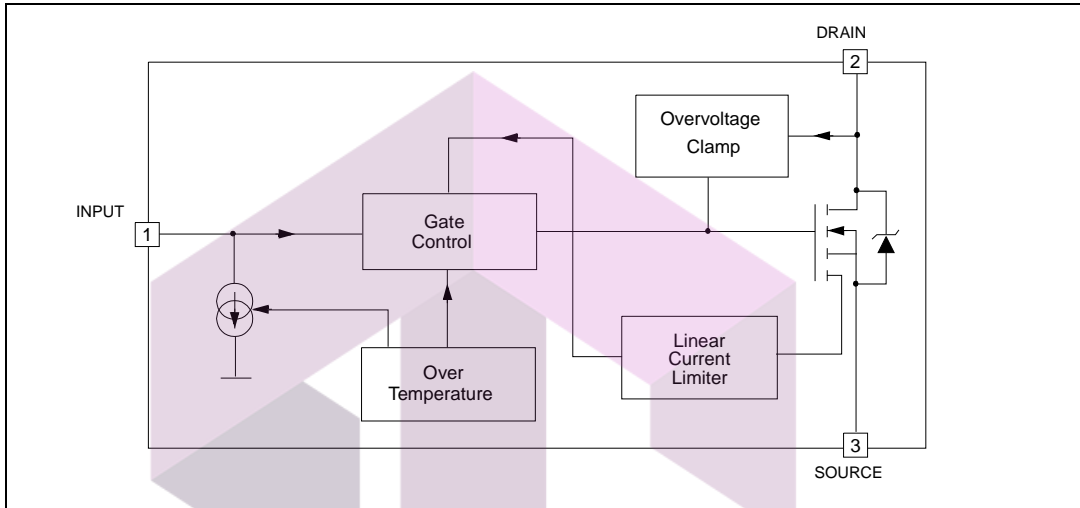
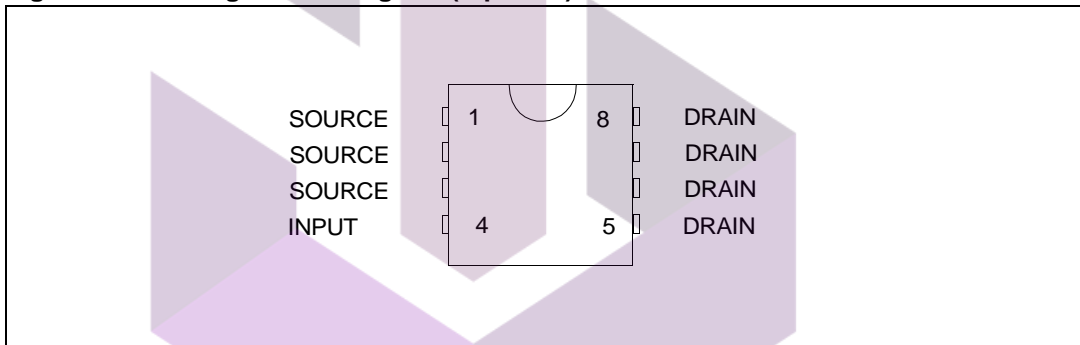

Figure 2. Configuration diagram (top view)



1. For the pins configuration related to SOT-223 and DPAK see outline at page 1.



2 Electrical specifications

Figure 3. Current and voltage conventions

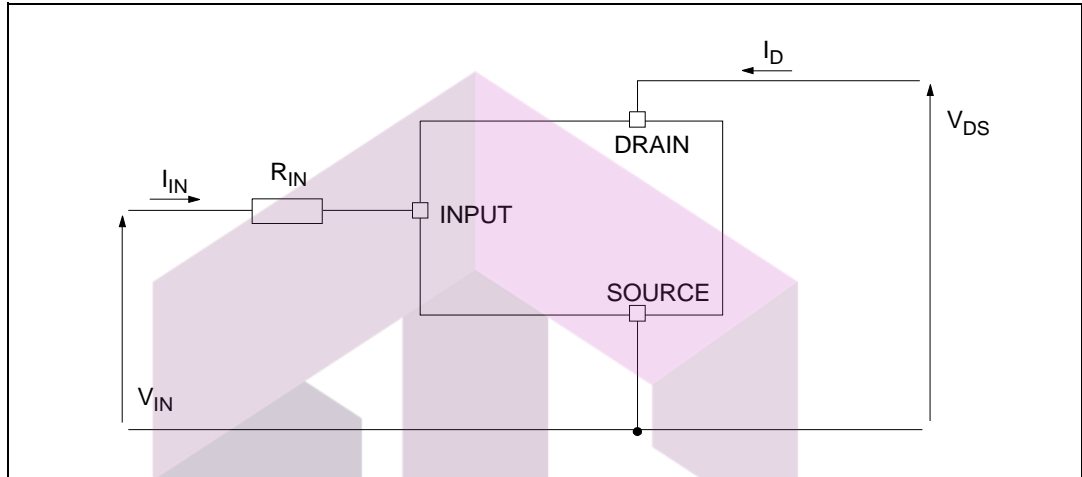

2.1 Absolute maximum ratings

The rating listed in [Table 2: Absolute maximum ratings](#) may cause permanent damage to the device. These are stress ratings only and operation of the device at these or any other conditions above those indicated in the operating sections of this specification is not implied. Exposure to Absolute maximum rating conditions for extended periods may affect device reliability.

Table 2. Absolute maximum ratings

| Symbol | Parameter | Value | | | Unit |
|----------------|---|--------------------|------|------|------------------|
| | | SOT-223 | SO-8 | DPAK | |
| V_{DSn} | Drain-source voltage ($V_{INn}=0\text{ V}$) | Internally clamped | | | V |
| V_{INn} | Input voltage | Internally clamped | | | V |
| I_{INn} | Input current | +/-20 | | | mA |
| $R_{IN\ MINn}$ | Minimum input series impedance | 330 | | | Ω |
| I_{Dn} | Drain current | Internally limited | | | A |
| I_{Rn} | Reverse DC output current | -3 | | | A |
| V_{ESD1} | Electrostatic discharge ($R=1.5\text{ K}\Omega$, $C=100\text{ pF}$) | 4000 | | | V |
| V_{ESD2} | Electrostatic discharge on output pins only ($R=330\ \Omega$, $C=150\text{ pF}$) | 16500 | | | V |
| P_{tot} | Total dissipation at $T_c=25\text{ }^\circ\text{C}$ | 7 | 8.3 | 35 | W |
| T_j | Operating junction temperature | Internally limited | | | $^\circ\text{C}$ |
| T_c | Case operating temperature | Internally limited | | | $^\circ\text{C}$ |
| T_{stg} | Storage temperature | -55 to 150 | | | $^\circ\text{C}$ |

2.2 Thermal data

Table 3. Thermal data

| Symbol | Parameter | Maximum value | | | Unit |
|----------------|-------------------------------------|-------------------|-------------------|-------------------|------|
| | | SOT-223 | SO-8 | DPAK | |
| $R_{thj-case}$ | Thermal resistance junction-case | 18 | | 3.5 | °C/W |
| $R_{thj-lead}$ | Thermal resistance junction-lead | | 15 | | °C/W |
| $R_{thj-amb}$ | Thermal resistance junction-ambient | 70 ⁽¹⁾ | 65 ⁽¹⁾ | 54 ⁽¹⁾ | °C/W |

1. When mounted on a standard single-sided FR4 board with 50 mm² of Cu (at least 35 μm thick) connected to all DRAIN pins

2.3 Electrical characteristics

Table 4. Electrical characteristics

| Symbol | Parameter | Test conditions | Min. | Typ. | Max. | Unit |
|--|--|---|------|------|------|------|
| Off (-40 °C < T_j < 150 °C, unless otherwise specified) | | | | | | |
| V_{CLAMP} | Drain-source clamp voltage | $V_{IN}=0\text{ V}; I_D=0.5\text{ A}$ | 40 | 45 | 55 | V |
| V_{CLTH} | Drain-source clamp threshold voltage | $V_{IN}=0\text{ V}; I_D=2\text{ mA}$ | 36 | | | V |
| V_{INTH} | Input threshold voltage | $V_{DS}=V_{IN}; I_D=1\text{ mA}$ | 0.5 | | 2.5 | V |
| I_{ISS} | Supply current from input pin | $V_{DS}=0\text{ V}; V_{IN}=5\text{ V}$ | | 100 | 150 | μA |
| V_{INCL} | Input-source clamp voltage | $I_{IN}=1\text{ mA}$ | 6 | 6.8 | 8 | V |
| | | $I_{IN}=-1\text{ mA}$ | -1.0 | | -0.3 | |
| I_{DSS} | Zero input voltage drain current ($V_{IN}=0\text{ V}$) | $V_{DS}=13\text{ V}; V_{IN}=0\text{ V}; T_j=25\text{ °C}$ | | | 30 | μA |
| | | $V_{DS}=25\text{ V}; V_{IN}=0\text{ V}$ | | | 75 | |
| On (-40 °C < T_j < 150 °C, unless otherwise specified) | | | | | | |
| $R_{DS(on)}$ | Static drain-source on resistance | $V_{IN}=5\text{ V}; I_D=0.5\text{ A}; T_j=25\text{ °C}$ | | | 250 | mΩ |
| | | $V_{IN}=5\text{ V}; I_D=0.5\text{ A}$ | | | 500 | |
| Dynamic (T_j=25 °C, unless otherwise specified) | | | | | | |
| $g_{fs}^{(1)}$ | Forward transconductance | $V_{DD}=13\text{ V}; I_D=0.5\text{ A}$ | | 2 | | S |
| C_{OSS} | Output capacitance | $V_{DS}=13\text{ V}; f=1\text{ MHz}; V_{IN}=0\text{ V}$ | | 90 | | pF |

تهیه و توزیع قطعات الکترونیک

Table 4. Electrical characteristics (continued)

| Symbol | Parameter | Test conditions | Min. | Typ. | Max. | Unit | |
|---|-------------------------------|---|------|------|------|------------------|----|
| Switching ($T_j=25\text{ }^\circ\text{C}$, unless otherwise specified) | | | | | | | |
| $t_{d(on)}$ | Turn-on delay time | $V_{DD}=15\text{ V}$; $I_D=0.5\text{ A}$ $V_{gen}=5\text{ V}$; $R_{gen}=R_{IN\text{ MIN}}=330\ \Omega$ (see Figure 4) | | 70 | 200 | ns | |
| t_r | Rise time | | | 170 | 500 | ns | |
| $t_{d(off)}$ | Turn-off delay time | | | 350 | 1000 | ns | |
| t_f | Fall time | | | 200 | 600 | ns | |
| $t_{d(on)}$ | Turn-on delay time | $V_{DD}=15\text{ V}$; $I_D=0.5\text{ A}$ $V_{gen}=5\text{ V}$; $R_{gen}=2.2\text{ K}\Omega$ (see Figure 4) | | 0.25 | 1.0 | μs | |
| t_r | Rise time | | | 1.3 | 4.0 | μs | |
| $t_{d(off)}$ | Turn-off delay time | | | 1.8 | 5.5 | μs | |
| t_f | Fall time | | | 1.2 | 4.0 | μs | |
| $(dI/dt)_{on}$ | Turn-on current slope | $V_{DD}=15\text{ V}$; $I_D=1.5\text{ A}$ $V_{gen}=5\text{ V}$; $R_{gen}=R_{IN\text{ MIN}}=330\ \Omega$ | | 5 | | A/ μs | |
| Q_i | Total input charge | $V_{DD}=12\text{ V}$; $I_D=0.5\text{ A}$; $V_{IN}=5\text{ V}$ $I_{gen}=2.13\text{ mA}$ (see Figure 7) | | 5 | | nC | |
| Source drain diode ($T_j=25\text{ }^\circ\text{C}$, unless otherwise specified) | | | | | | | |
| $V_{SD}^{(1)}$ | Forward on voltage | $I_{SD}=0.5\text{ A}$; $V_{IN}=0\text{ V}$ | | 0.8 | | V | |
| t_{rr} | Reverse recovery time | $I_{SD}=0.5\text{ A}$; $dI/dt=6\text{ A}/\mu\text{s}$ $V_{DD}=30\text{ V}$; $L=200\ \mu\text{H}$ (see Figure 5) | | 205 | | ns | |
| Q_{rr} | Reverse recovery charge | | | | 100 | | nC |
| I_{RRM} | Reverse recovery current | | | | 0.7 | | A |
| Protections ($-40\text{ }^\circ\text{C}<T_j<150\text{ }^\circ\text{C}$, unless otherwise specified) | | | | | | | |
| I_{lim} | Drain current limit | $V_{IN}=5\text{ V}$; $V_{DS}=13\text{ V}$ | 1.7 | | 3.5 | A | |
| t_{dlim} | Step response current limit | $V_{IN}=5\text{ V}$; $V_{DS}=13\text{ V}$ | | 2.0 | | μs | |
| T_{jsh} | Overtemperature shutdown | | 150 | 175 | 200 | $^\circ\text{C}$ | |
| T_{jrs} | Overtemperature reset | | 135 | | | $^\circ\text{C}$ | |
| I_{gf} | Fault sink current | $V_{IN}=5\text{ V}$; $V_{DS}=13\text{ V}$; $T_j=T_{jsh}$ | 10 | 15 | 20 | mA | |
| E_{as} | Single pulse avalanche energy | Starting $T_j=25\text{ }^\circ\text{C}$; $V_{DD}=24\text{ V}$ $V_{IN}=5\text{ V}$ $R_{gen}=R_{IN\text{ MIN}}=330\ \Omega$; $L=50\text{ mH}$ (see Figure 6 and Figure 8) | 55 | | | mJ | |

1. Pulsed: pulse duration = 300 μs , duty cycle 1.5 %

تهیه و توزیع قطعات الکترونیک

Figure 4. Switching time test circuit for resistive load

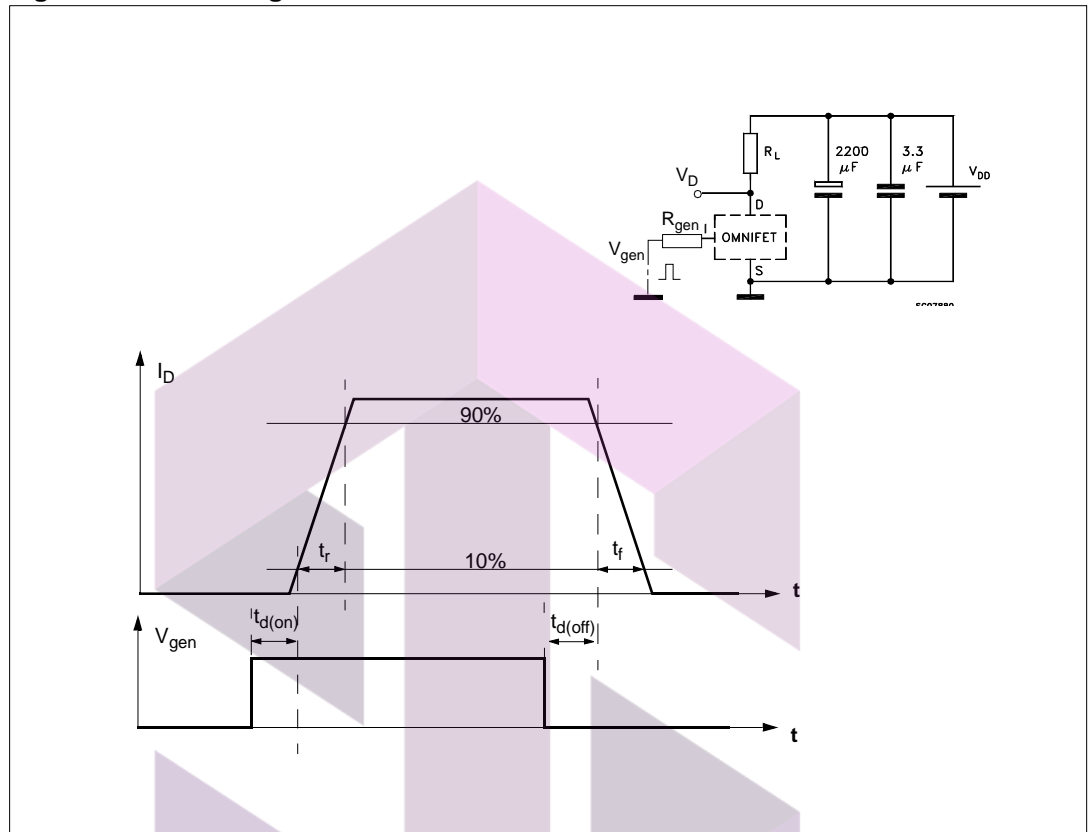

SKYTECH

تهیه و توزیع قطعات الکترونیک

Figure 5. Test circuit for diode recovery times

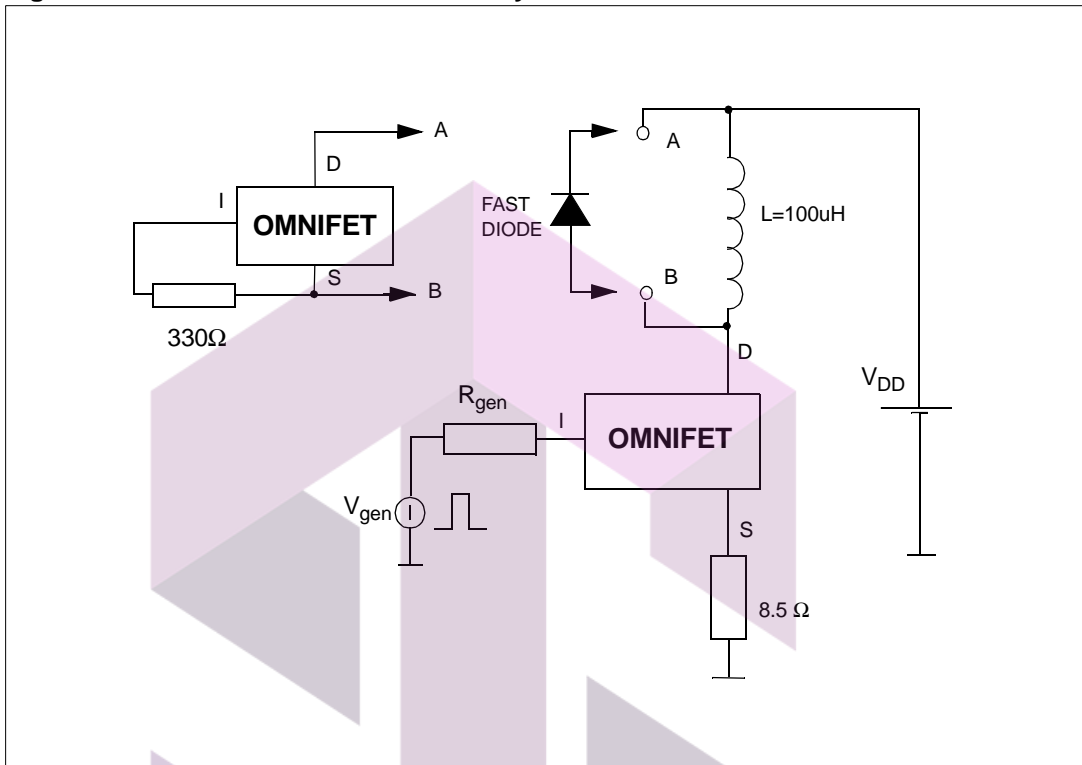
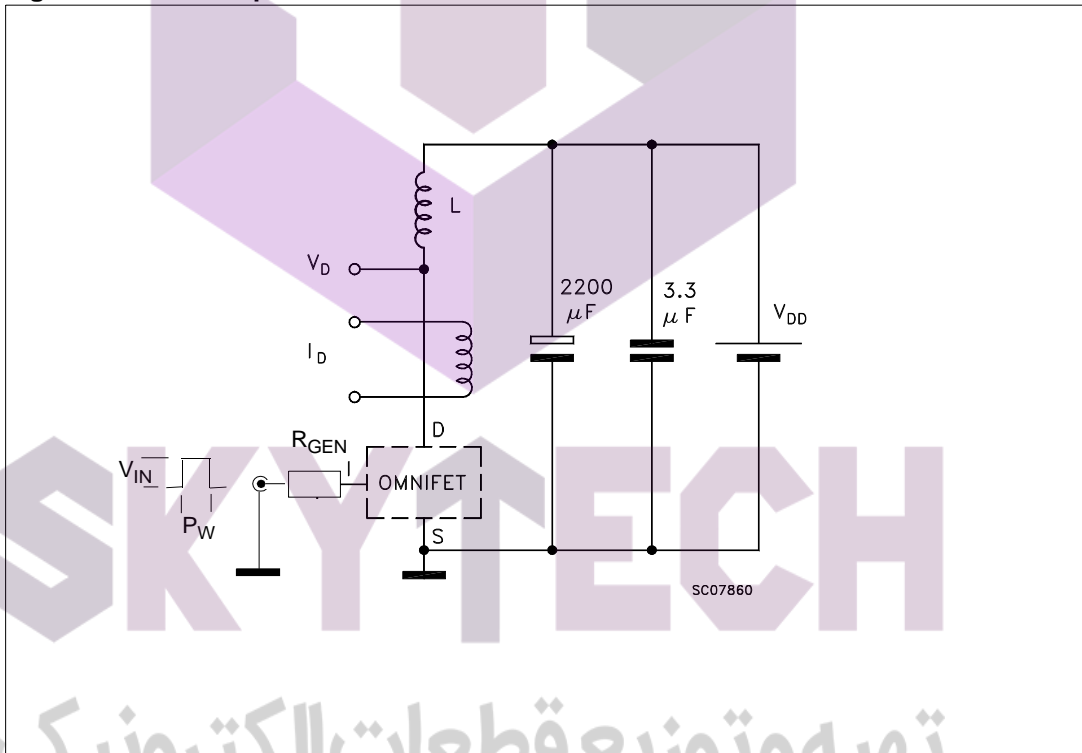

Figure 6. Unclamped inductive load test circuits



2.4 Electrical characteristics curves

Figure 9. Source-drain diode forward characteristics

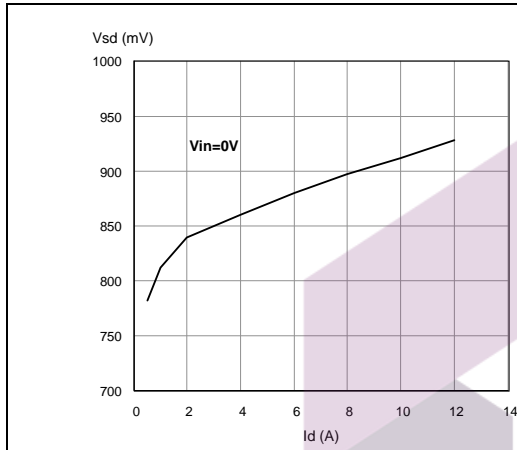

Figure 10. Static drain-source on resistance

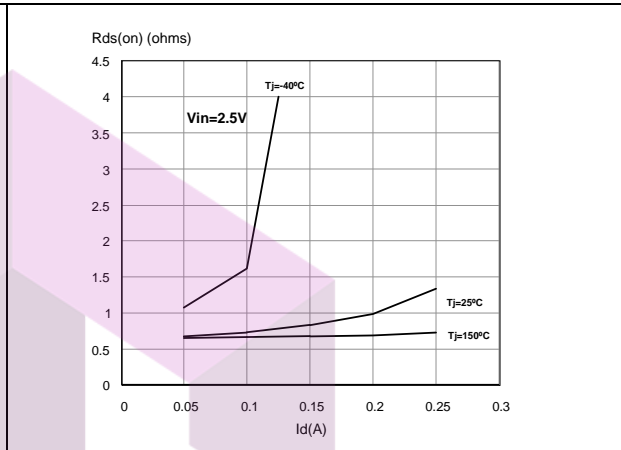

Figure 11. Derating curve

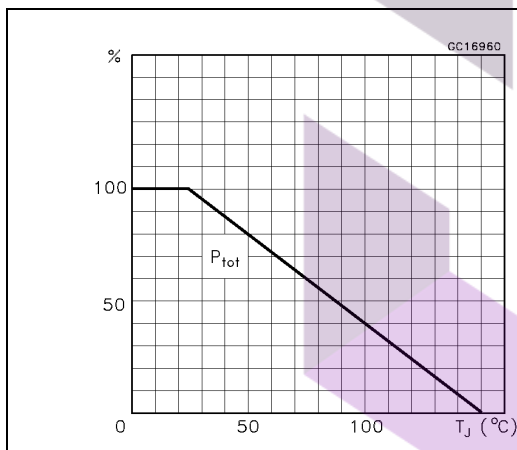

Figure 12. Static drain-source on resistance vs. input voltage (part 1/2)

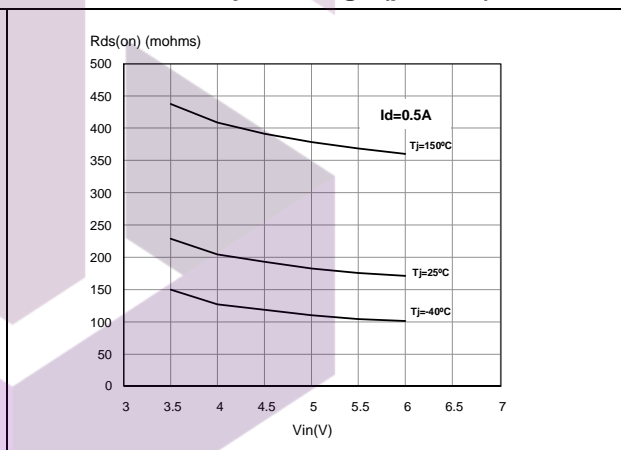

Figure 13. Static drain-source on resistance vs. input voltage (part 2/2)

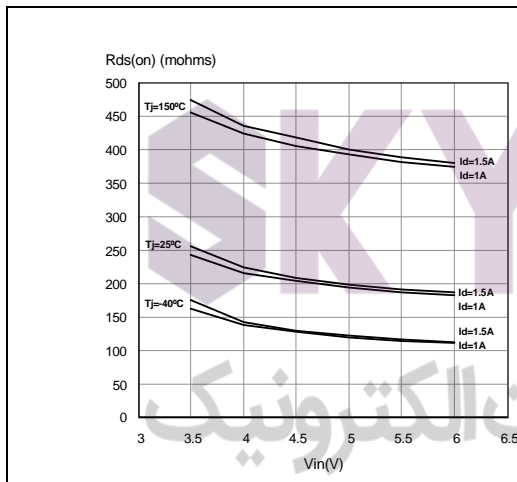

Figure 14. Transconductance

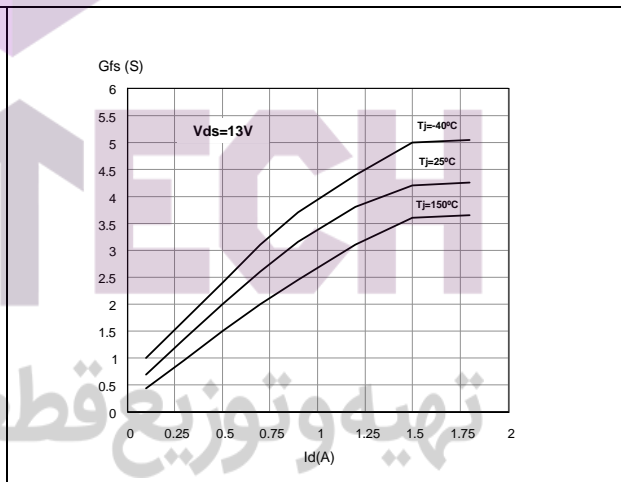

Figure 15. Static drain-source on resistance vs. Id

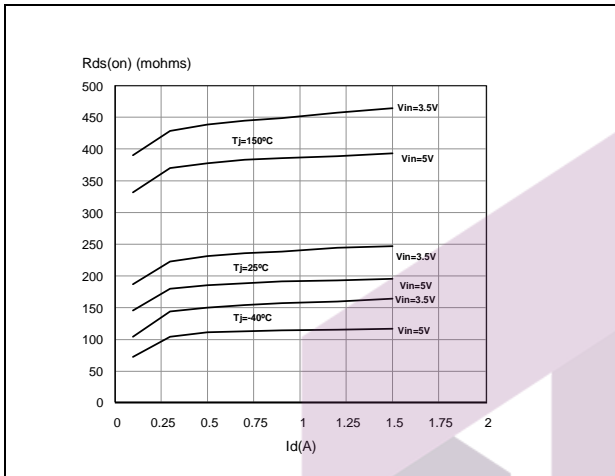

Figure 16. Transfer characteristics

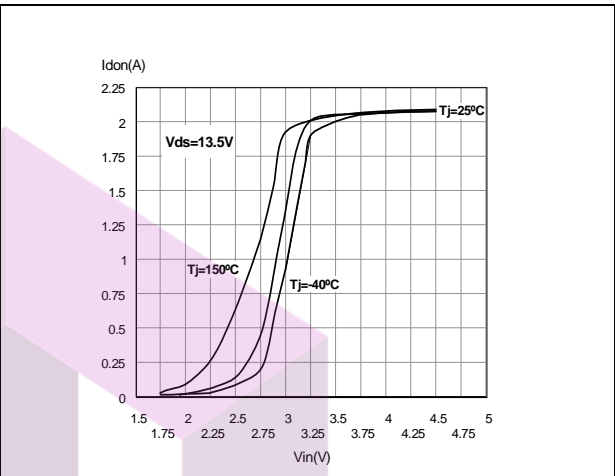

Figure 17. Turn-on current slope (part 1/2)

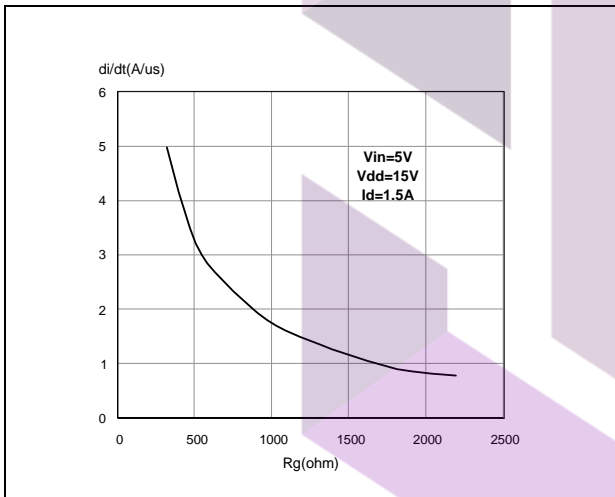

Figure 18. Turn-on current slope (part 2/2)

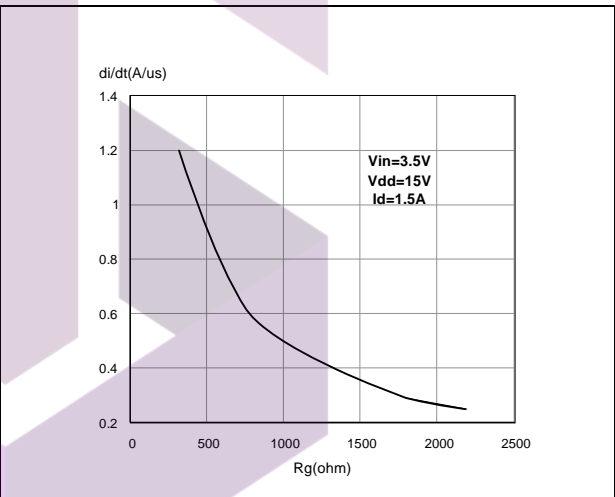

Figure 19. Input voltage vs. input charge

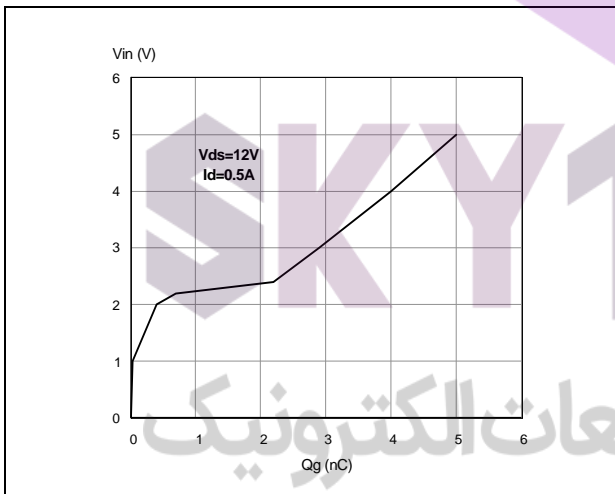

Figure 20. Turn-off drain source voltage slope (part 1/2)

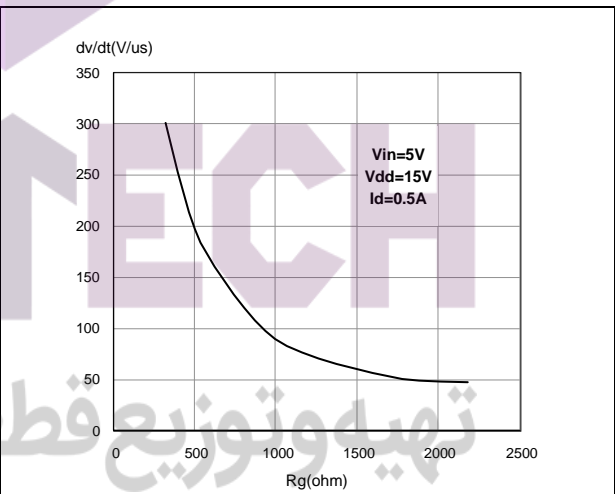

Figure 21. Turn-off drain-source voltage slope (part 2/2) Figure 22. Capacitance variations

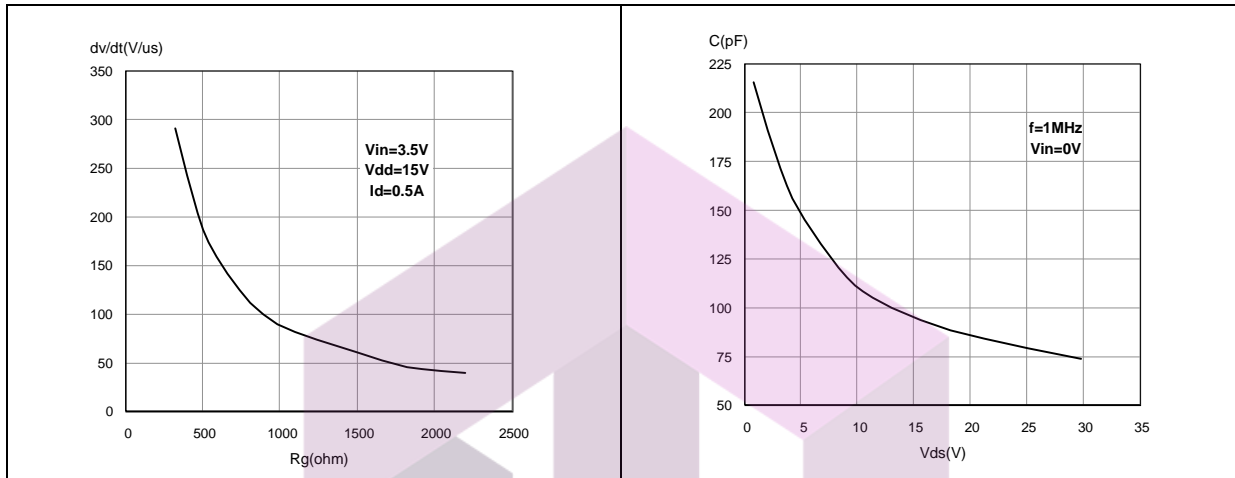

Figure 23. Switching time resistive load (part 1/2)

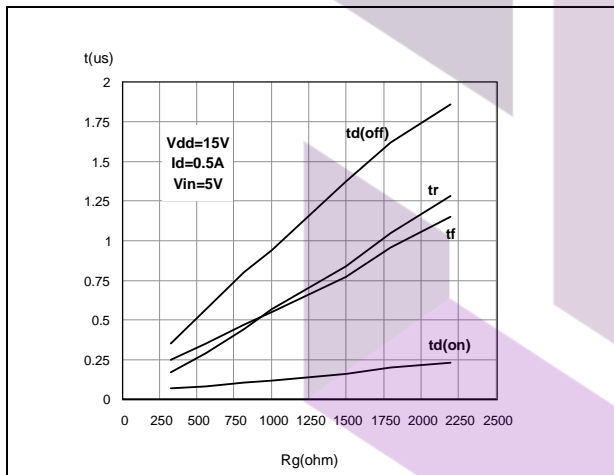

Figure 24. Switching time resistive load (part 2/2)

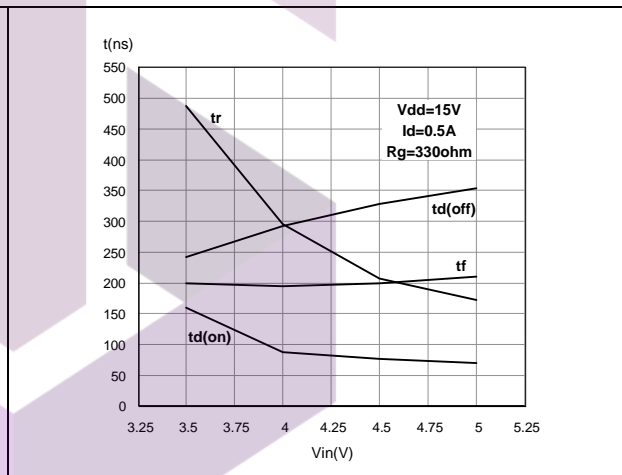

Figure 25. Output characteristics

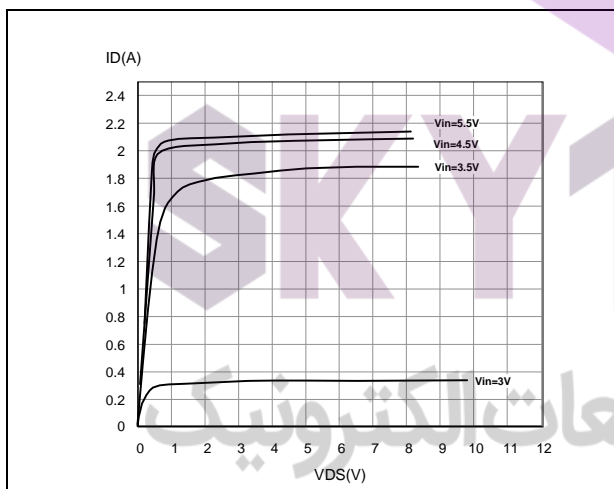

Figure 26. Normalized on resistance vs. temperature

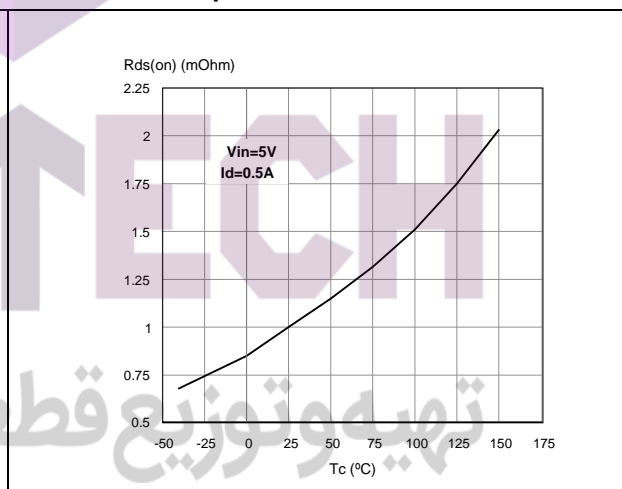

Figure 27. Normalized input threshold voltage vs. temperature **Figure 28. Normalized current limit vs. junction temperature**

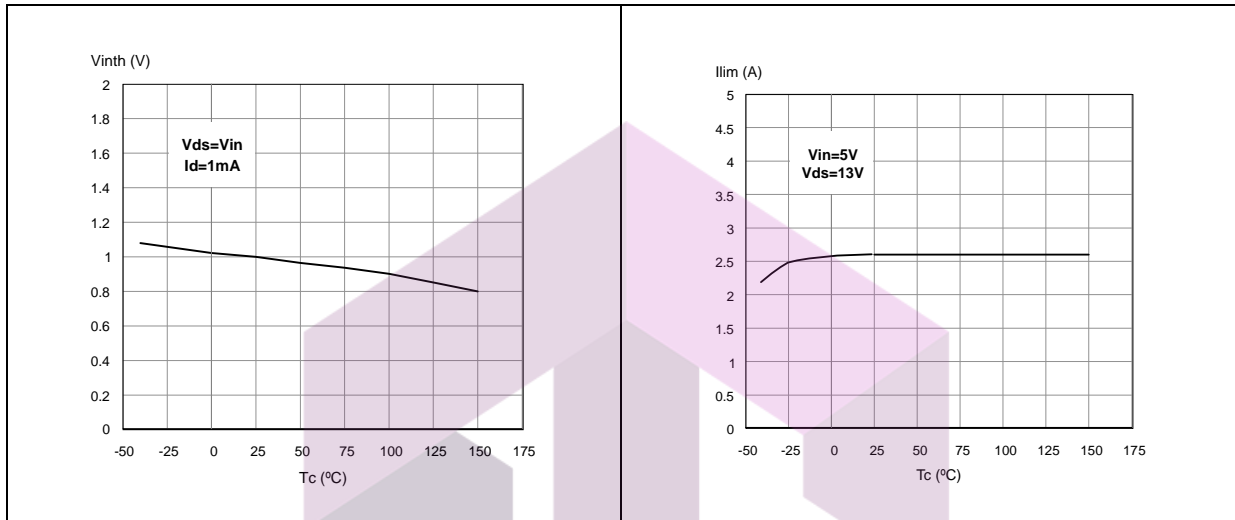
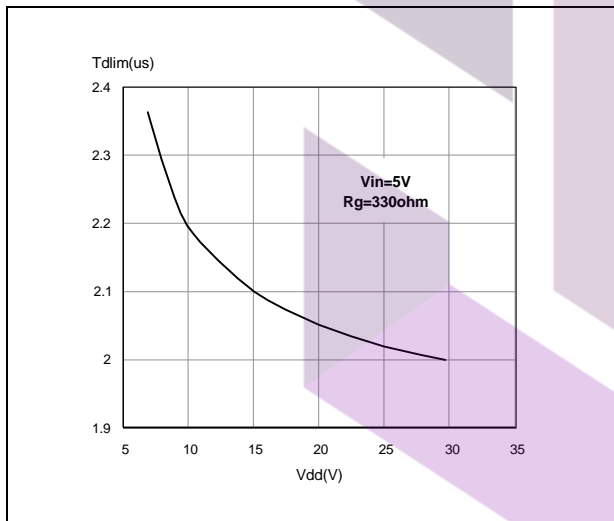

Figure 29. Step response current limit



SKYTECH

تهیه و توزیع قطعات الکترونیک

3 Protection features

During normal operation, the input pin is electrically connected to the gate of the internal Power MOSFET through a low impedance path.

The device behaves like a standard Power MOSFET and it can be used as a switch from DC up to 50 KHz. The only difference from the user's point of view is that a small DC current I_{ISS} (typ. 100 μ A) flows into the input pin in order to supply the internal circuitry.

The device integrates:

- Overvoltage clamp protection gives
 - Internally set at 45 V, along with the rugged avalanche characteristics of the Power MOSFET stage give this device unrivalled ruggedness and energy handling capability. This feature is mainly important when driving inductive loads.
- Linear current limiter circuit
 - Limits the drain current I_D to I_{lim} whatever the input pin voltages. When the current limiter is active, the device operates in the linear region, so power dissipation may exceed the capability of the heatsink. Both case and junction temperatures increase, and if this phase lasts long enough, junction temperature may reach the overtemperature threshold T_{jsh} .
- Overtemperature and short circuit protection
 - These are based on sensing the chip temperature and are not dependent on the input voltage. The location of the sensing element on the chip in the power stage area ensures fast, accurate detection of the junction temperature. Overtemperature cutout ranges is from 150 to 190 °C, a typical value is 170 °C. The device is automatically restarted when the chip temperature falls of about 15 °C below shutdown temperature.
- Status feedback
 - In the case of an overtemperature fault condition ($T_j > T_{jsh}$), the device tries to sink a diagnostic current I_{gf} through the input pin in order to indicate fault condition. If driven from a low impedance source, this current may be used in order to warn the control circuit of a device shutdown. If the drive impedance is high enough so that the input pin driver is not able to supply the current I_{gf} , the input pin falls to 0 V. This does not however affect the device operation: no requirement is put on the current capability of the input pin driver except to be able to supply the normal operation drive current I_{ISS} . Additional features of this device are ESD protection according to the Human Body model and the ability to be driven from a TTL logic circuit.

SKYTECH

تهيئه وتوزيع قطعات الكترولنيك

4 Package and PCB thermal data

4.1 DPAK thermal data

Figure 30. DPAK PC board

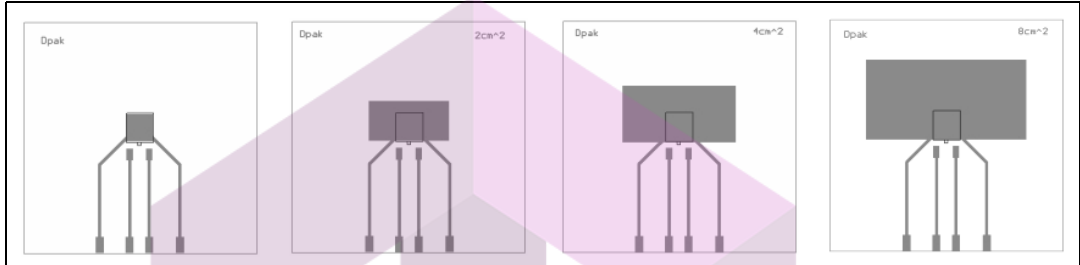

1. Layout condition of R_{th} and Z_{th} measurements (PCB FR4 area = 58 mm x 58 mm, PCB thickness = 2 mm, Cu thickness = 35 μ m, Copper areas: from minimum pad layout to 16 cm²).

Figure 31. DPAK $R_{thj-amb}$ vs. PCB copper area in open box free air condition

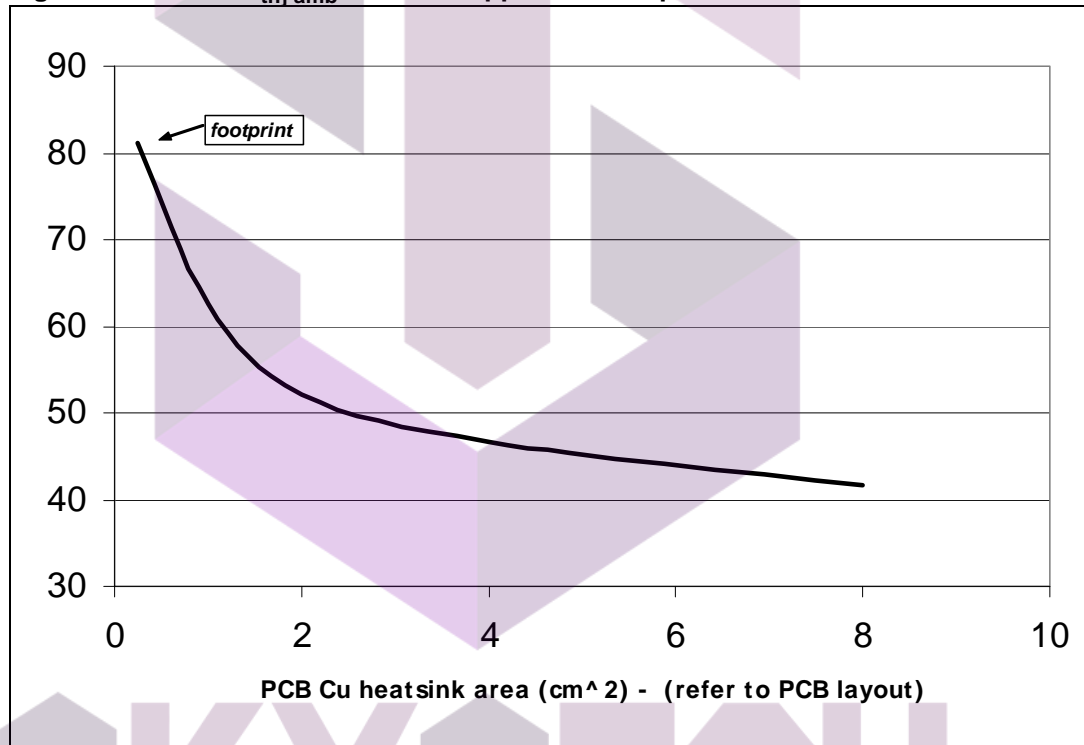

SKYTECH
تهیه و توزیع قطعات الکترونیک

Figure 32. DPAK thermal impedance junction ambient single pulse

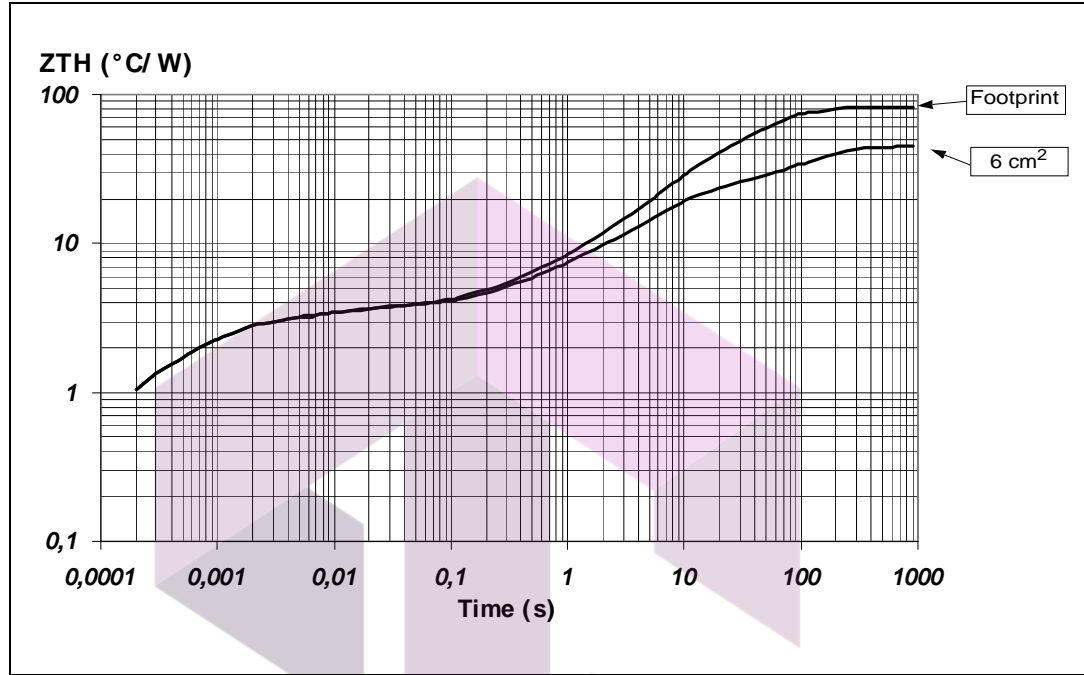

Equation 1: Pulse calculation formula

$$Z_{TH\delta} = R_{TH} \cdot \delta + Z_{THtp}(1 - \delta)$$

where $\delta = t_p/T$

Figure 33. DPAK thermal fitting model of a single channel

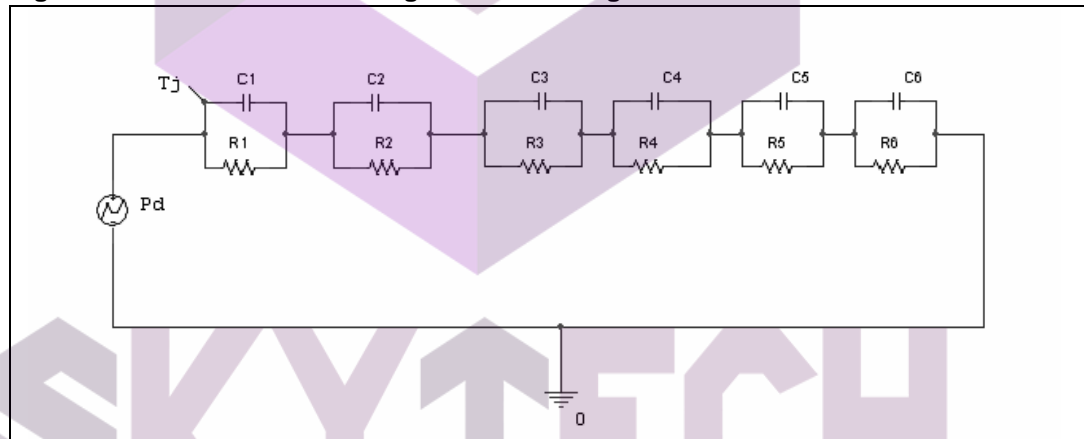

SKYTECH

تهیه و توزیع قطعات الکترونیک

Table 5. DPAK thermal parameter

| Area/island (cm ²) | 0.25 | 6 |
|--------------------------------|---------|----|
| R1 (°C/W) | 0.8 | |
| R2 (°C/W) | 1.6 | |
| R3 (°C/W) | 0.8 | |
| R4 (°C/W) | 2 | |
| R5 (°C/W) | 15 | |
| R6 (°C/W) | 61 | 24 |
| C1 (W·s/°C) | 0.00006 | |
| C2 (W·s/°C) | 0.0005 | |
| C3 (W·s/°C) | 0.01 | |
| C4 (W·s/°C) | 0.3 | |
| C5 (W·s/°C) | 0.45 | |
| C6 (W·s/°C) | 0.8 | 5 |

4.2 SOT-223 thermal data

Figure 34. SOT-223 PC board

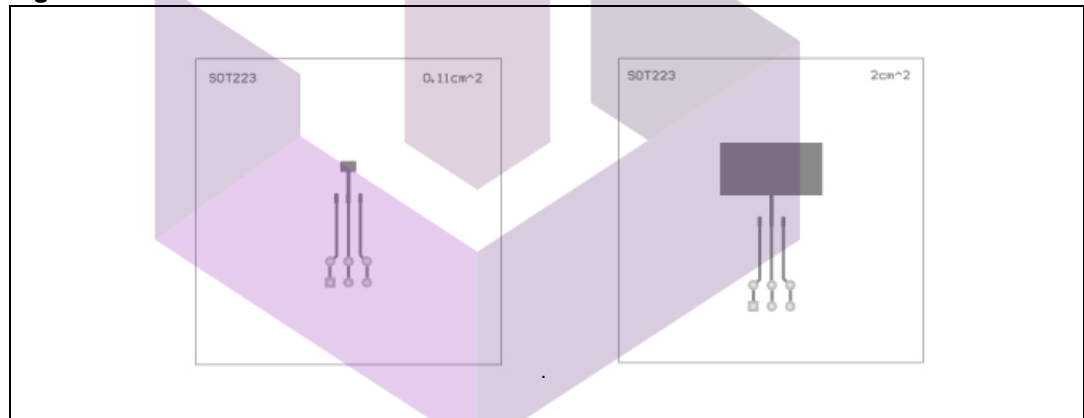

1. Layout condition of R_{th} and Z_{th} measurements (PCB FR4 area = 58 mm x 58 mm, PCB thickness = 2 mm, Cu thickness=35 μm, Copper areas: from minimum pad layout to 0.8 cm²).

SKYTECH

تهیه و توزیع قطعات الکترونیک

Figure 35. SOT-223 $R_{thj-amb}$ vs. PCB copper area in open box free air condition

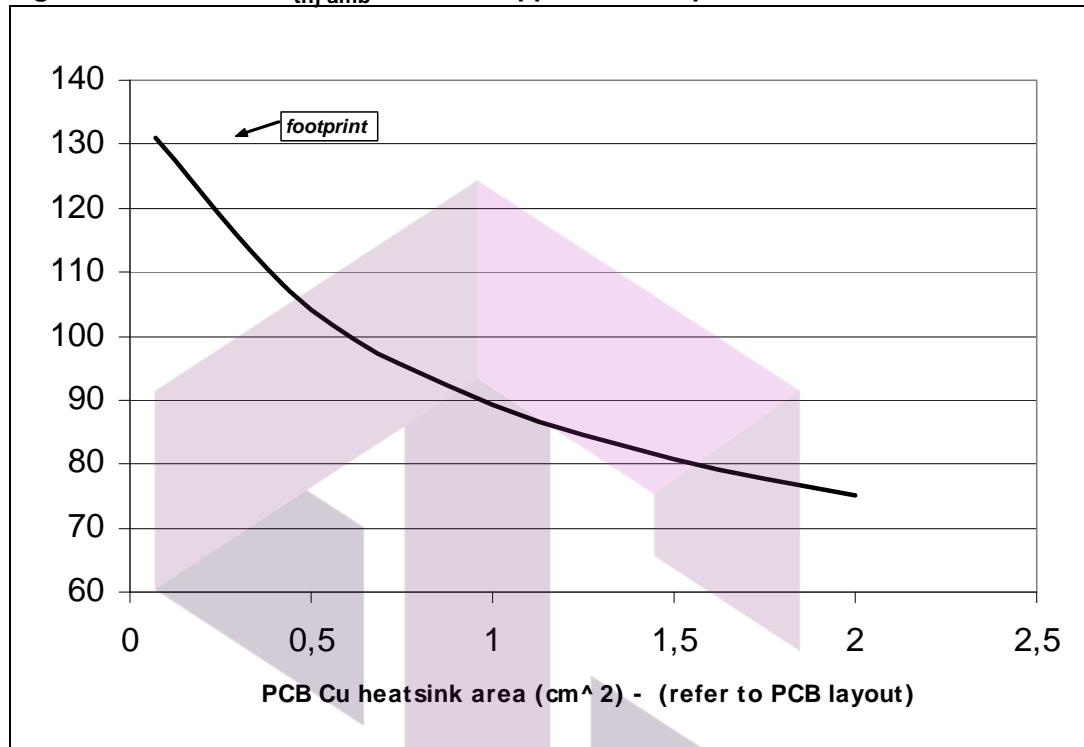
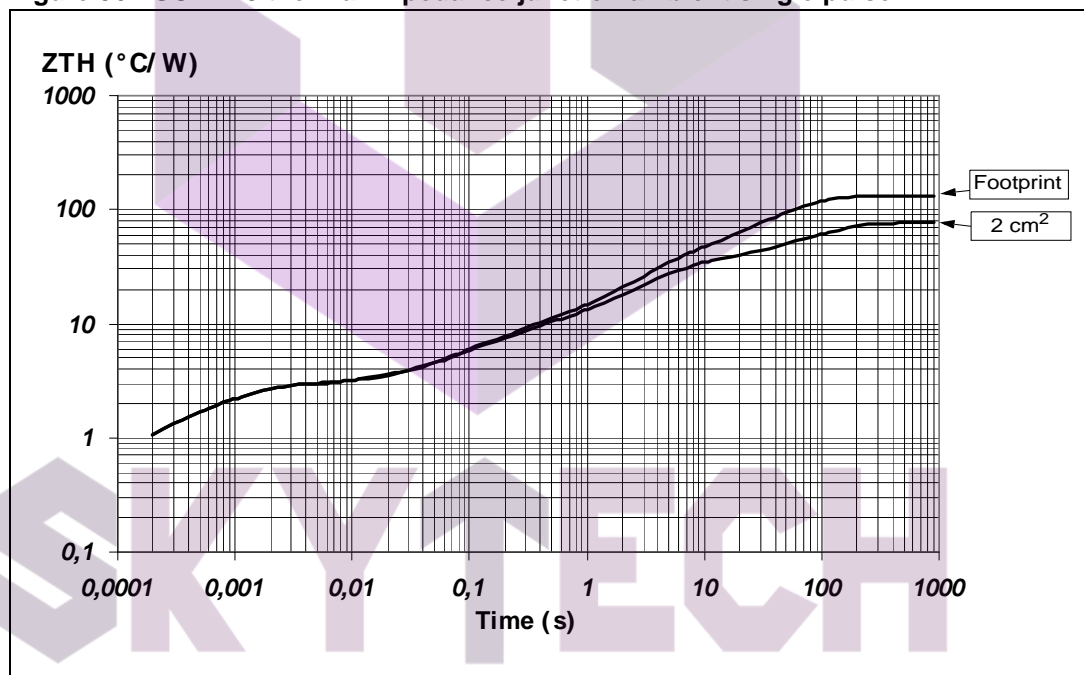

Figure 36. SOT-223 thermal impedance junction ambient single pulse



تهیه و توزیع قطعات الکترونیک

Equation 2: Pulse calculation formula

$$Z_{TH\delta} = R_{TH} \cdot \delta + Z_{THtp}(1 - \delta)$$

where $\delta = t_p/T$

Figure 37. SOT-223 thermal fitting model of a single channel

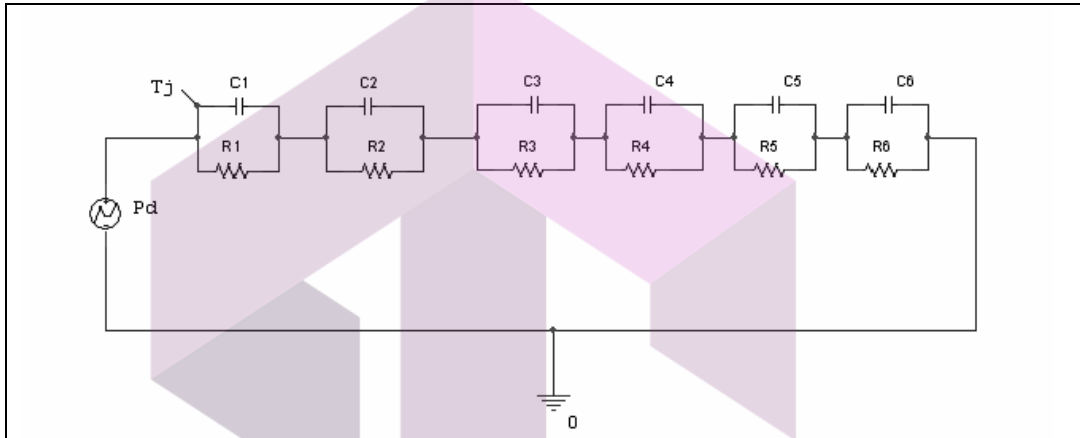

Table 6. SOT-223 thermal parameter

| Area/island (cm ²) | FP | 2 |
|--------------------------------|---------|----|
| R1 (°C/W) | 0.8 | |
| R2 (°C/W) | 1.6 | |
| R3 (°C/W) | 4.5 | |
| R4 (°C/W) | 24 | |
| R5 (°C/W) | 0.1 | |
| R6 (°C/W) | 100 | 45 |
| C1 (W·s/°C) | 0.00006 | |
| C2 (W·s/°C) | 0.0005 | |
| C3 (W·s/°C) | 0.03 | |
| C4 (W·s/°C) | 0.16 | |
| C5 (W·s/°C) | 1000 | |
| C6 (W·s/°C) | 0.5 | 2 |

SKYTECH
 تهیه و توزیع قطعات الکترونیک

4.3 SO-8 thermal data

Figure 38. SO-8 PC board

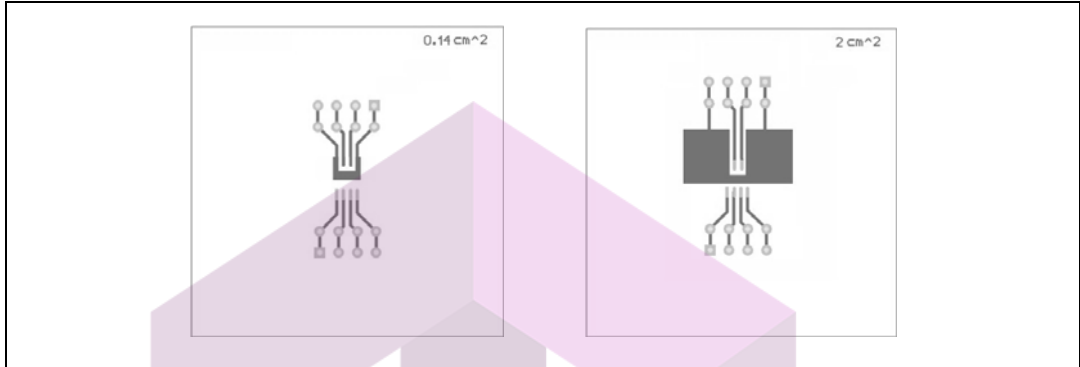

- 1. Layout condition of R_{th} and Z_{th} measurements (PCB FR4 area = 58 mm x 58 mm, PCB thickness = 2 mm, Cu thickness=35 μ m , Copper areas: from minimum pad layout to 2 cm²).

Figure 39. SO-8 $R_{thj-amb}$ vs. PCB copper area in open box free air condition

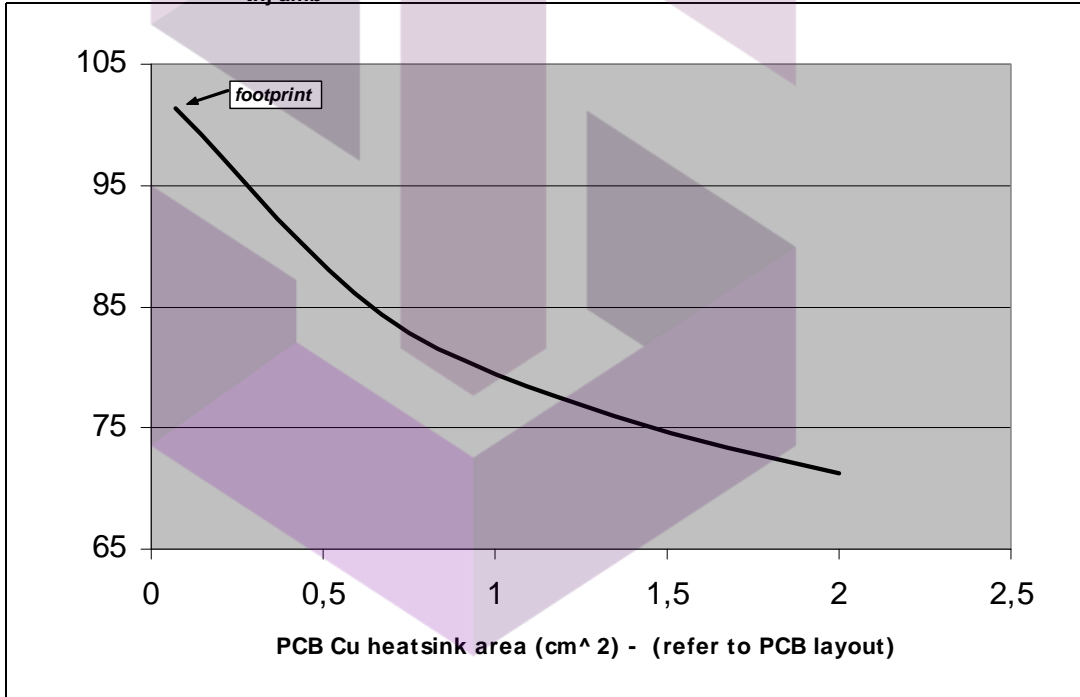

SKYTECH

تهیه و توزیع قطعات الکترونیک

Figure 40. SO-8 thermal impedance junction ambient single pulse

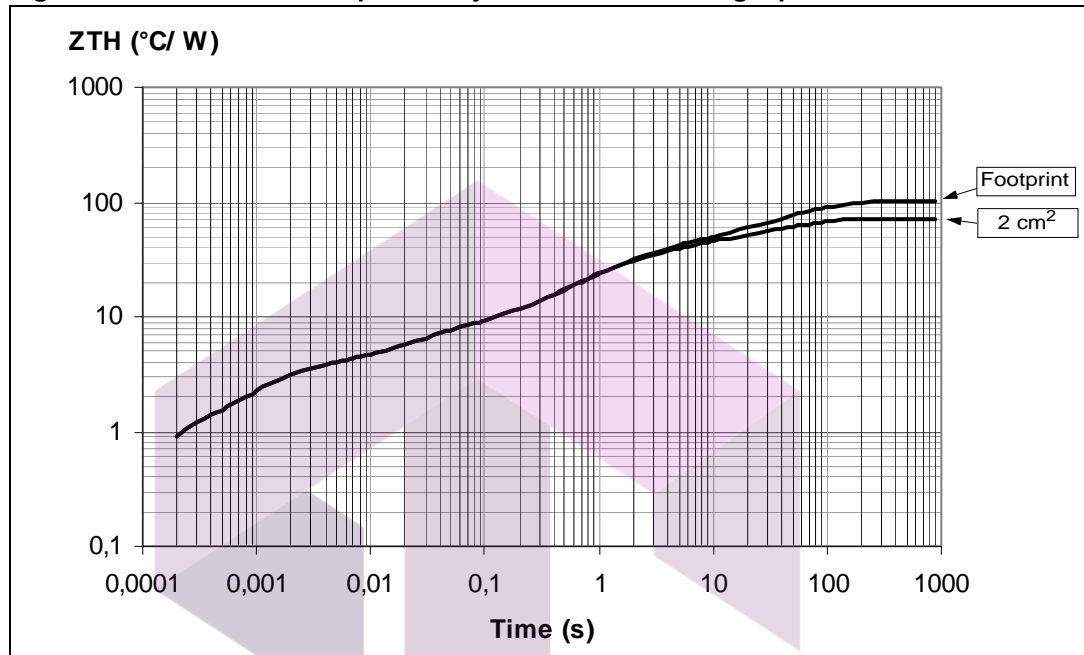

Equation 3: Pulse calculation formula

$$Z_{TH\delta} = R_{TH} \cdot \delta + Z_{THtp}(1 - \delta)$$

where $\delta = t_p/T$

Figure 41. SO-8 thermal fitting model of a single channel

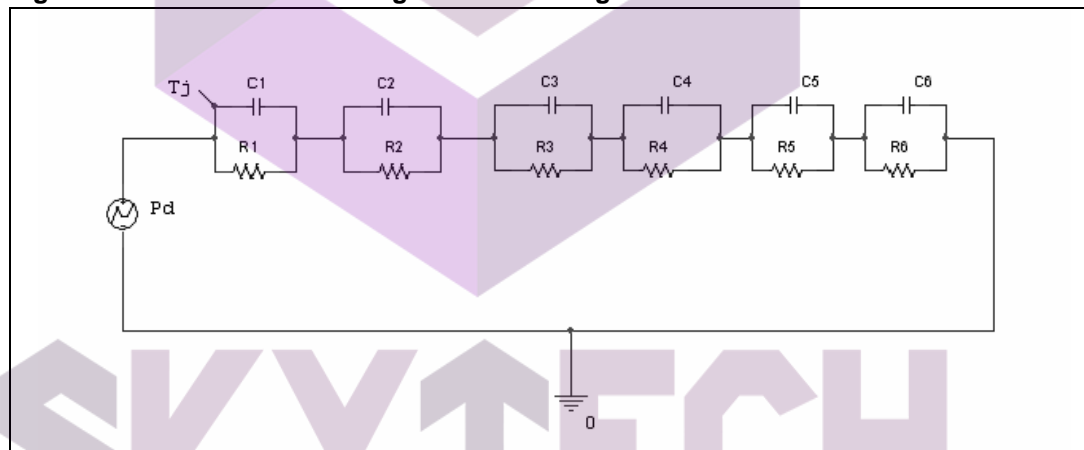

SKYTECH
تهیه و توزیع قطعات الکترونیک

Table 7. SO-8 thermal parameter

| Area/island (cm ²) | FP | 2 |
|--------------------------------|---------|----|
| R1 (°C/W) | 0.8 | |
| R2 (°C/W) | 2.6 | |
| R3 (°C/W) | 3.5 | |
| R4 (°C/W) | 21 | |
| R5 (°C/W) | 16 | |
| R6 (°C/W) | 58 | 28 |
| C1 (W·s/°C) | 0.00006 | |
| C2 (W·s/°C) | 0.0005 | |
| C3 (W·s/°C) | 0.0075 | |
| C4 (W·s/°C) | 0.045 | |
| C5 (W·s/°C) | 0.35 | |
| C6 (W·s/°C) | 1.05 | 2 |

SKYTECH

تهیه و توزیع قطعات الکترونیک

5 Package and packing information

In order to meet environmental requirements, ST offers these devices in different grades of ECOPACK® packages, depending on their level of environmental compliance. ECOPACK® specifications, grade definitions and product status are available at: www.st.com.

ECOPACK® is an ST trademark.

5.1 DPAK mechanical data

Figure 42. DPAK package dimensions

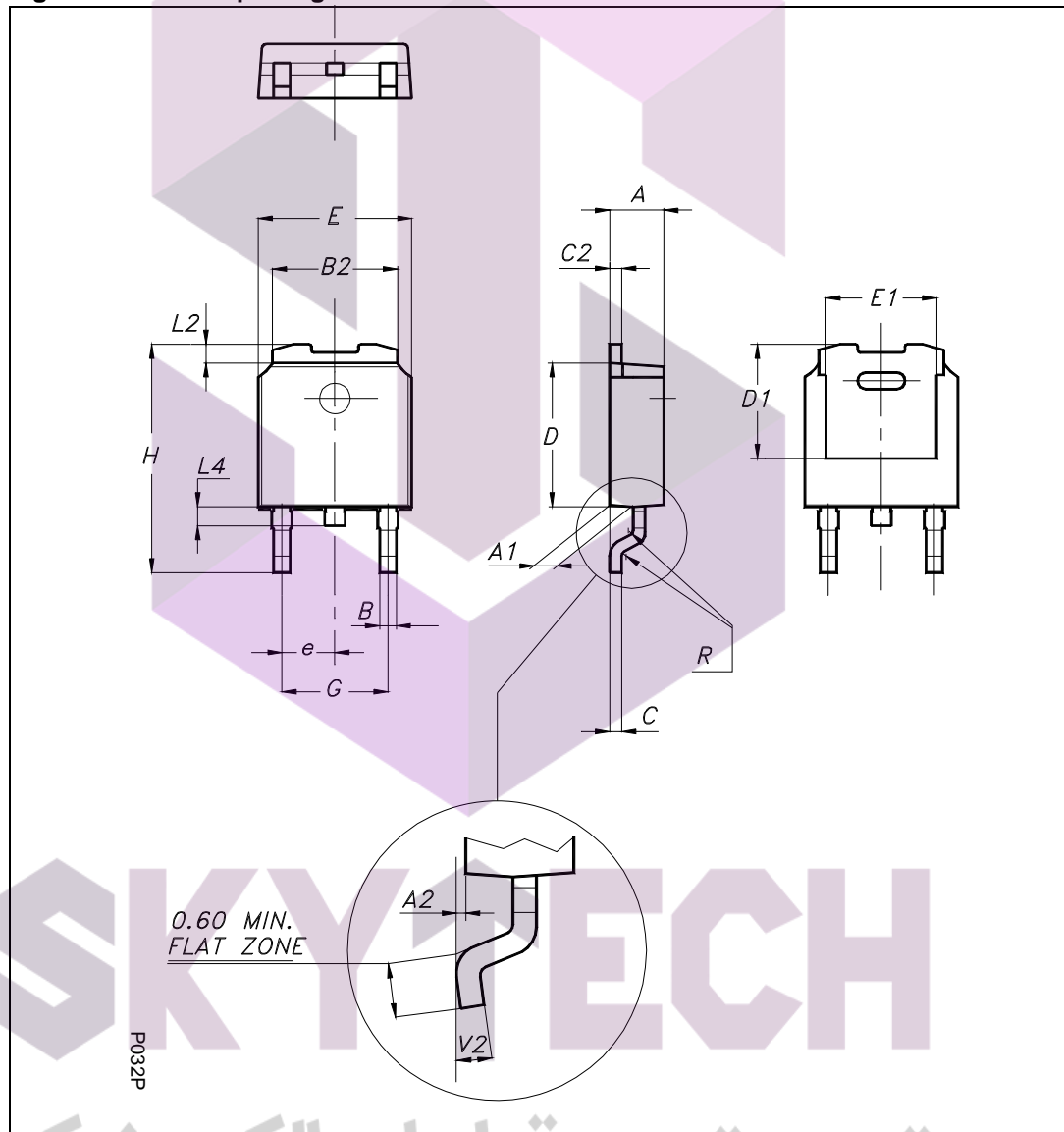

Table 8. DPAK mechanical data

| Dim. | mm. | | |
|----------------|----------|------|-------|
| | Min. | Typ. | Max. |
| A | 2.20 | | 2.40 |
| A1 | 0.90 | | 1.10 |
| A2 | 0.03 | | 0.23 |
| B | 0.64 | | 0.90 |
| B2 | 5.20 | | 5.40 |
| C | 0.45 | | 0.60 |
| C2 | 0.48 | | 0.60 |
| D | 6.00 | | 6.20 |
| D1 | | 5.1 | |
| E | 6.40 | | 6.60 |
| E1 | | 4.7 | |
| e | | 2.28 | |
| G | 4.40 | | 4.60 |
| H | 9.35 | | 10.10 |
| L2 | | 0.8 | |
| L4 | 0.60 | | 1.00 |
| R | | 0.2 | |
| V2 | 0° | 8° | |
| Package weight | Gr. 0.29 | | |

SKYTECH

تهیه و توزیع قطعات الکترونیک

5.2 SOT-223 mechanical data

Figure 43. SOT-223 mechanical data & package outline

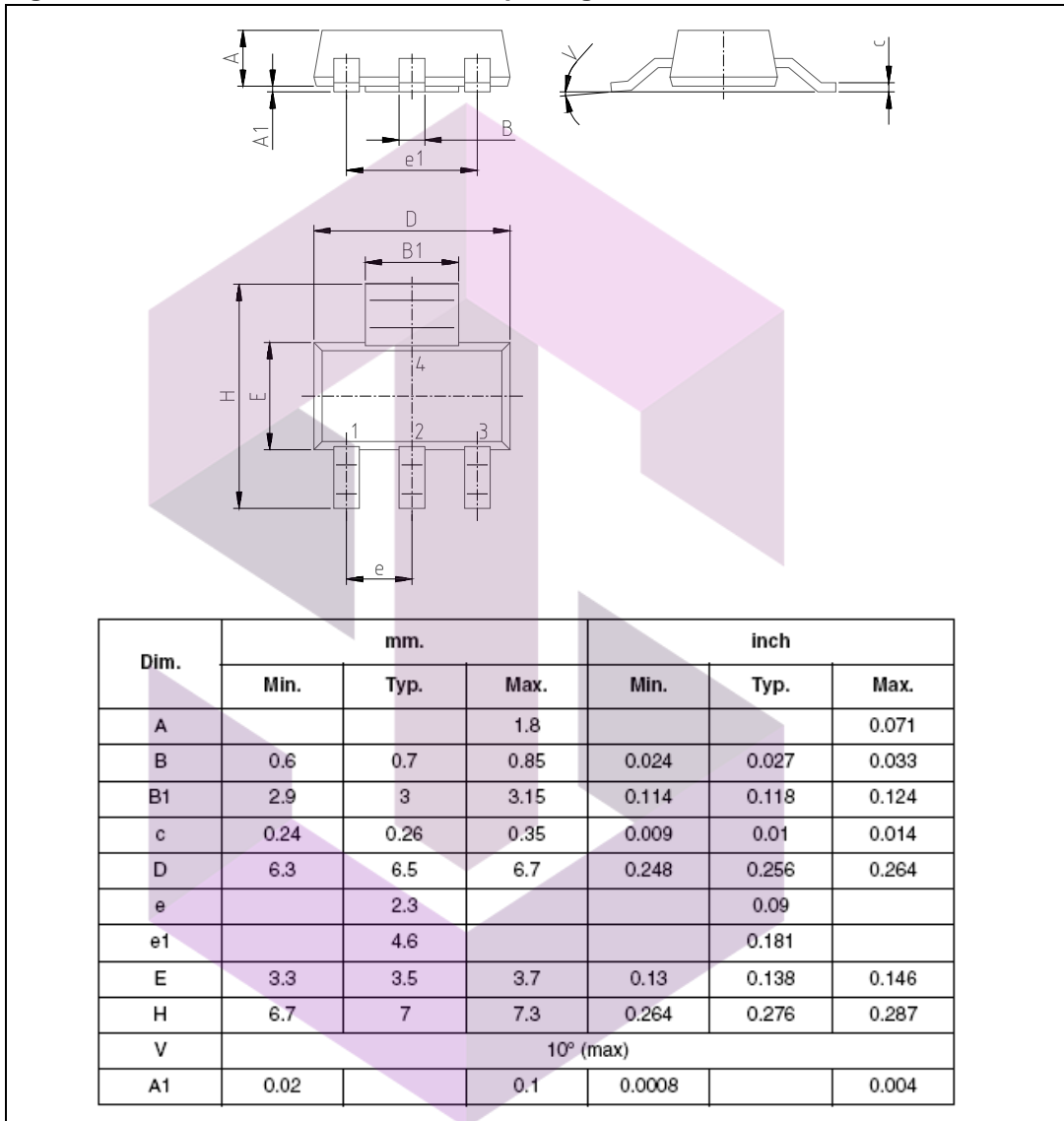

5.3 SO8 mechanical data

Table 9. SO-8 mechanical data

| Dim. | mm | | |
|------|------|------|------|
| | Min. | Typ. | Max. |
| A | | | 1.75 |
| A1 | 0.10 | | 0.25 |
| A2 | 1.25 | | |

Table 9. SO-8 mechanical data (continued)

| Dim. | mm | | |
|-------------------|------|------|------|
| | Min. | Typ. | Max. |
| b | 0.28 | | 0.48 |
| c | 0.17 | | 0.23 |
| D ⁽¹⁾ | 4.80 | 4.90 | 5.00 |
| E | 5.80 | 6.00 | 6.20 |
| E1 ⁽²⁾ | 3.80 | 3.90 | 4.00 |
| e | | 1.27 | |
| h | 0.25 | | 0.50 |
| L | 0.40 | | 1.27 |
| L1 | | 1.04 | |
| k | 0° | | 8° |
| ccc | | | 0.10 |

1. Dimension "D" does not include mold flash, protrusions or gate burrs. Mold flash, protrusions or gate burrs shall not exceed 0.15 mm in total (both side).
2. Dimension "E1" does not include interlead flash or protrusions. Interlead flash or protrusions shall not exceed 0.25 mm per side.

Figure 44. SO-8 package dimension

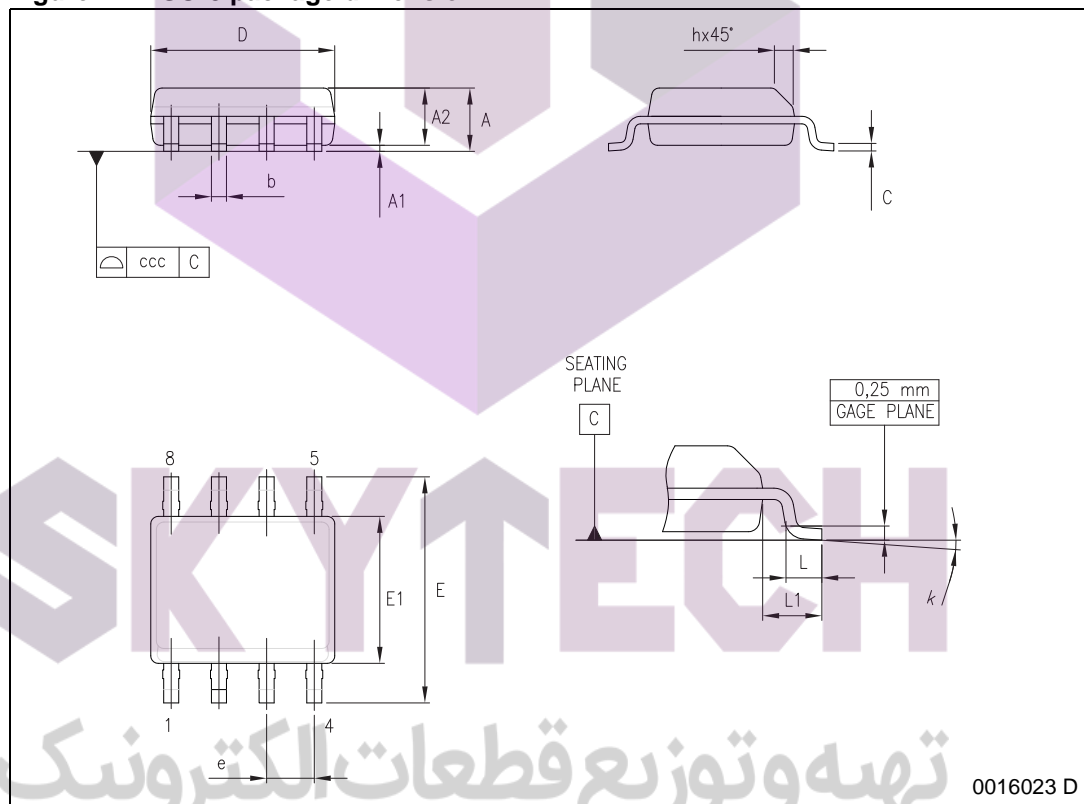

5.4 DPAK packing information

The devices can be packed in tube or tape and reel shipments (see the [Table 1: Device summary](#)).

DPAK FOOTPRINT

TUBE SHIPMENT (no suffix)

| | |
|----------------------------|------|
| Base Q.ty | 75 |
| Bulk Q.ty | 3000 |
| Tube length (± 0.5) | 532 |
| A | 6 |
| B | 21.3 |
| C (± 0.1) | 0.6 |

All dimensions are in mm.

TAPE AND REEL SHIPMENT (suffix "13TR")

REEL DIMENSIONS

| | |
|---------------------|------|
| Base Q.ty | 2500 |
| Bulk Q.ty | 2500 |
| A (max) | 330 |
| B (min) | 1.5 |
| C (± 0.2) | 13 |
| F | 20.2 |
| G (+ 2 / -0) | 16.4 |
| N (min) | 60 |
| T (max) | 22.4 |

TAPE DIMENSIONS

According to Electronic Industries Association (EIA) Standard 481 rev. A, Feb 1986

| | | |
|--------------------------|---------------------|-----|
| Tape width | W | 16 |
| Tape Hole Spacing | P0 (± 0.1) | 4 |
| Component Spacing | P | 8 |
| Hole Diameter | D (± 0.1/-0) | 1.5 |
| Hole Diameter | D1 (min) | 1.5 |
| Hole Position | F (± 0.05) | 7.5 |
| Compartment Depth | K (max) | 6.5 |
| Hole Spacing | P1 (± 0.1) | 2 |

All dimensions are in mm.

تهیه و توزیع قطعات الکترونیک

5.5 SOT-223 packing information

Figure 45. SOT-223 tape and reel shipment (suffix "TR")

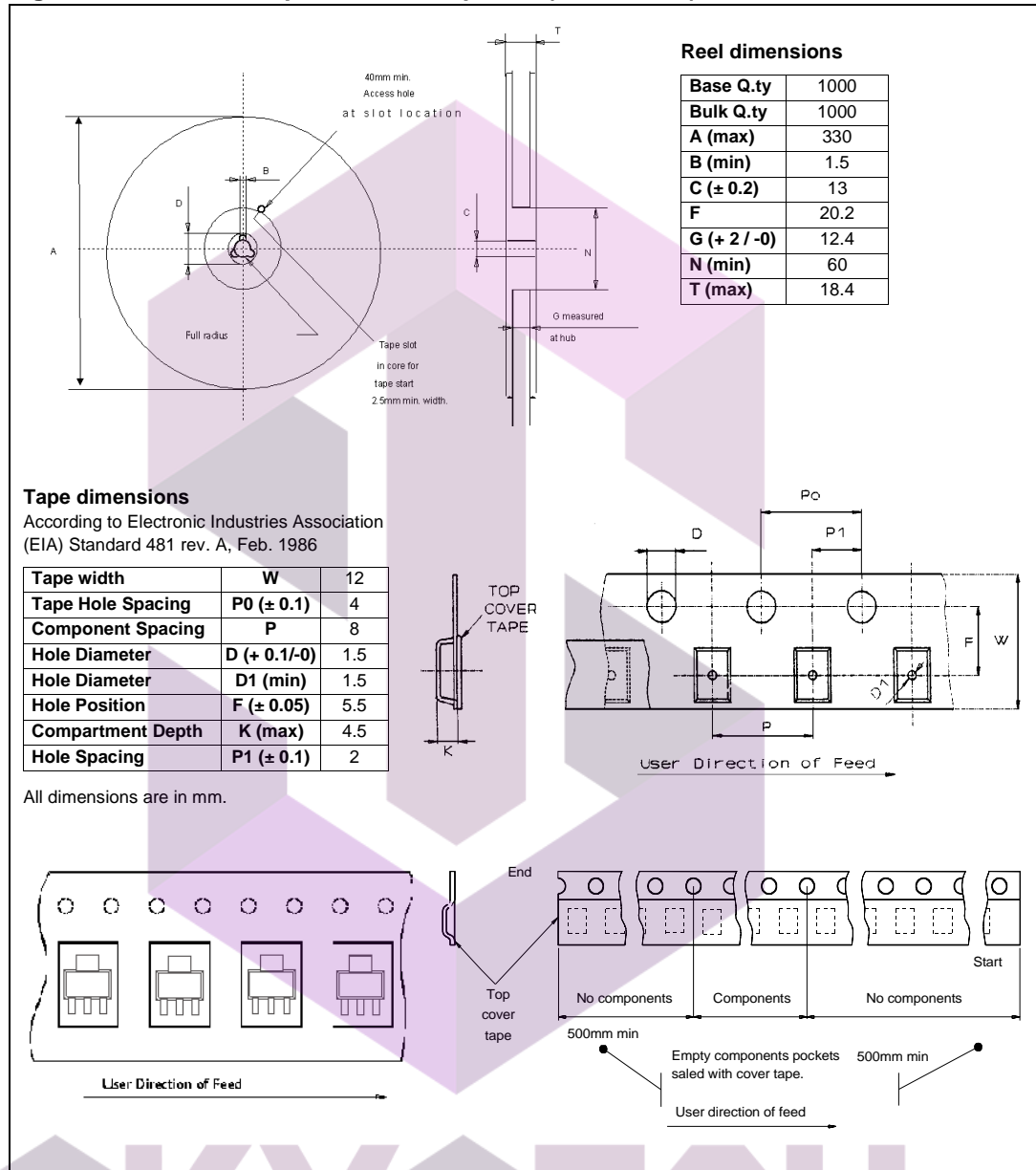

5.6 SO8 packing information

Figure 46. SO-8 tube shipment (no suffix)

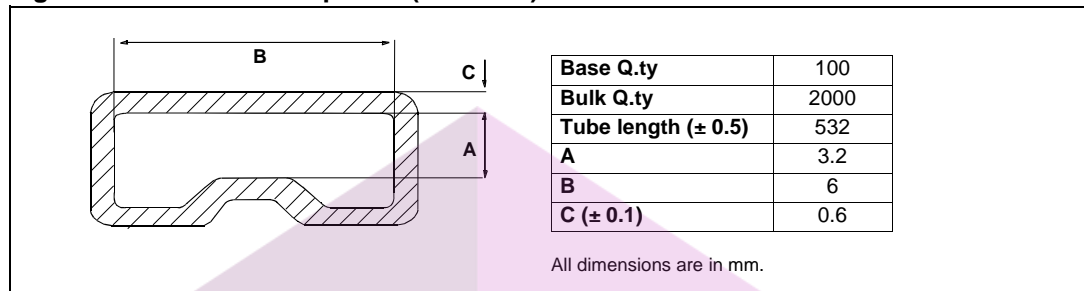
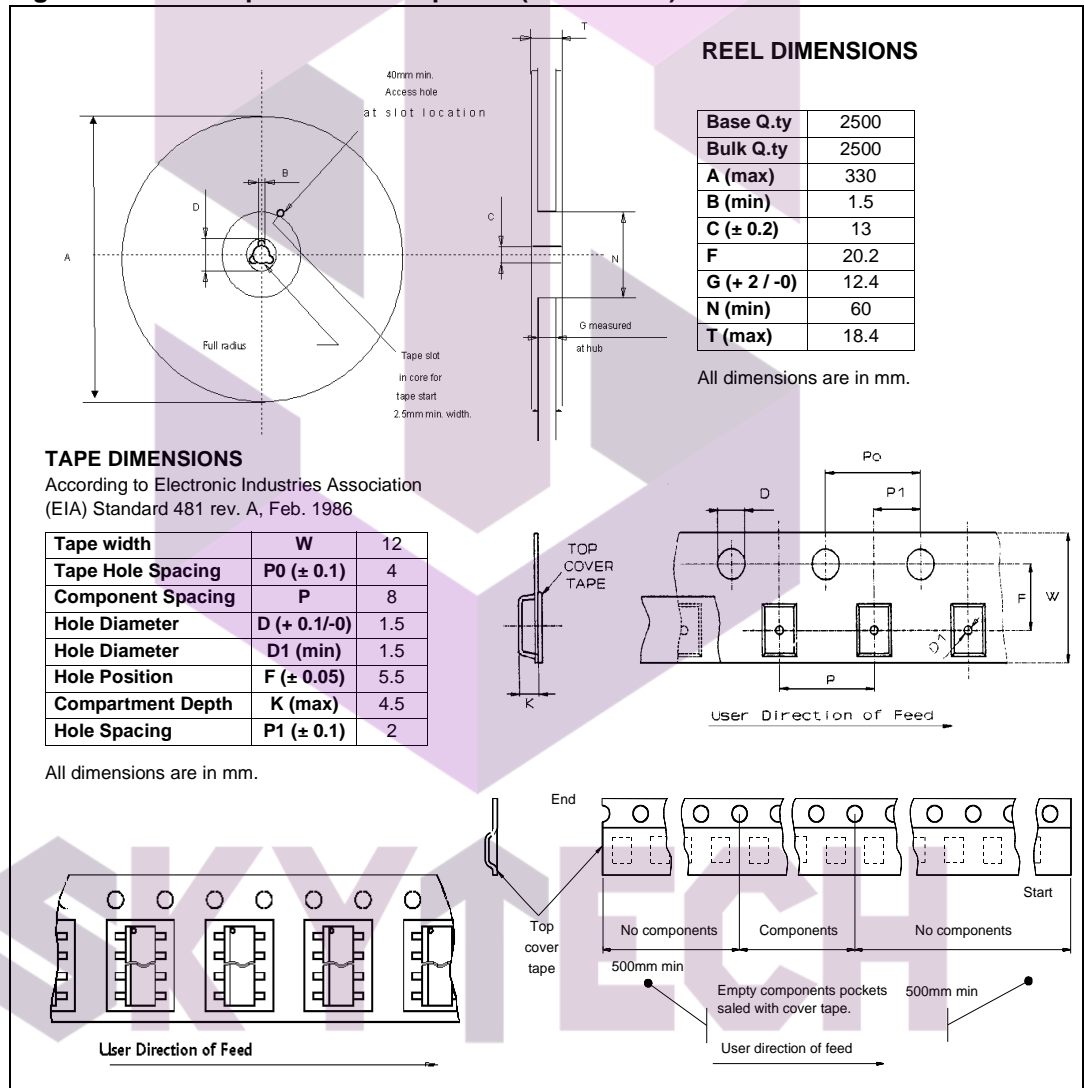

Figure 47. SO-8 tape and reel shipment (suffix "TR")



تهیه و توزیع قطعات الکترونیک

6 Revision history

Table 10. Document revision history

| Date | Revision | Changes |
|-------------|----------|---|
| Feb-2003 | 1 | Initial release. |
| 16-Apr-2009 | 2 | Added <i>Table 1: Device summary</i> and <i>Section 4: Package and PCB thermal data</i> Updated <i>Section 5: Package and packing information on page 25</i> |
| 01-Dic-2011 | 3 | Update <i>Table 1: Device summary</i> . Update the entire document using the new corporate template. |
| 20-Sep-2013 | 4 | Updated Disclaimer. |



Please Read Carefully:

Information in this document is provided solely in connection with ST products. STMicroelectronics NV and its subsidiaries ("ST") reserve the right to make changes, corrections, modifications or improvements, to this document, and the products and services described herein at any time, without notice.

All ST products are sold pursuant to ST's terms and conditions of sale.

Purchasers are solely responsible for the choice, selection and use of the ST products and services described herein, and ST assumes no liability whatsoever relating to the choice, selection or use of the ST products and services described herein.

No license, express or implied, by estoppel or otherwise, to any intellectual property rights is granted under this document. If any part of this document refers to any third party products or services it shall not be deemed a license grant by ST for the use of such third party products or services, or any intellectual property contained therein or considered as a warranty covering the use in any manner whatsoever of such third party products or services or any intellectual property contained therein.

UNLESS OTHERWISE SET FORTH IN ST'S TERMS AND CONDITIONS OF SALE ST DISCLAIMS ANY EXPRESS OR IMPLIED WARRANTY WITH RESPECT TO THE USE AND/OR SALE OF ST PRODUCTS INCLUDING WITHOUT LIMITATION IMPLIED WARRANTIES OF MERCHANTABILITY, FITNESS FOR A PARTICULAR PURPOSE (AND THEIR EQUIVALENTS UNDER THE LAWS OF ANY JURISDICTION), OR INFRINGEMENT OF ANY PATENT, COPYRIGHT OR OTHER INTELLECTUAL PROPERTY RIGHT.

ST PRODUCTS ARE NOT DESIGNED OR AUTHORIZED FOR USE IN: (A) SAFETY CRITICAL APPLICATIONS SUCH AS LIFE SUPPORTING, ACTIVE IMPLANTED DEVICES OR SYSTEMS WITH PRODUCT FUNCTIONAL SAFETY REQUIREMENTS; (B) AERONAUTIC APPLICATIONS; (C) AUTOMOTIVE APPLICATIONS OR ENVIRONMENTS, AND/OR (D) AEROSPACE APPLICATIONS OR ENVIRONMENTS. WHERE ST PRODUCTS ARE NOT DESIGNED FOR SUCH USE, THE PURCHASER SHALL USE PRODUCTS AT PURCHASER'S SOLE RISK, EVEN IF ST HAS BEEN INFORMED IN WRITING OF SUCH USAGE, UNLESS A PRODUCT IS EXPRESSLY DESIGNATED BY ST AS BEING INTENDED FOR "AUTOMOTIVE, AUTOMOTIVE SAFETY OR MEDICAL" INDUSTRY DOMAINS ACCORDING TO ST PRODUCT DESIGN SPECIFICATIONS. PRODUCTS FORMALLY ESCC, QML OR JAN QUALIFIED ARE DEEMED SUITABLE FOR USE IN AEROSPACE BY THE CORRESPONDING GOVERNMENTAL AGENCY.

Resale of ST products with provisions different from the statements and/or technical features set forth in this document shall immediately void any warranty granted by ST for the ST product or service described herein and shall not create or extend in any manner whatsoever, any liability of ST.

ST and the ST logo are trademarks or registered trademarks of ST in various countries.

Information in this document supersedes and replaces all information previously supplied.

The ST logo is a registered trademark of STMicroelectronics. All other names are the property of their respective owners.

© 2013 STMicroelectronics - All rights reserved

STMicroelectronics group of companies

Australia - Belgium - Brazil - Canada - China - Czech Republic - Finland - France - Germany - Hong Kong - India - Israel - Italy - Japan - Malaysia - Malta - Morocco - Philippines - Singapore - Spain - Sweden - Switzerland - United Kingdom - United States of America

www.st.com